

# Oil Piston Pumps PANTHER® HP 3:1 Pumps

The Panther® HP 3:1 ratio double acting pump is engineered for outstanding performance and reliability for dispensing lubricating oils and similar products up to SAE 90.



## Fluids & Applications

Pride Series pumps are manufactured with a mechanical air valve and piston design which is more forgiving to environments with contaminated air. The 3:1 version is a medium pressure pump for supplying higher volume than the 5:1 version but at lower operating pressures ideal for medium pumping distances and overall flow rates of 4-5 gpm.

### Fluids

- Synthetic and mineral based lubricants
- Hydraulic fluid
- Transmission fluid

### Applications

- Medium sized tank packages
- Medium volume maintenance shops
- Small car dealerships
- Quick lubes

**Pressure relief valve kit included with this pump.**

1

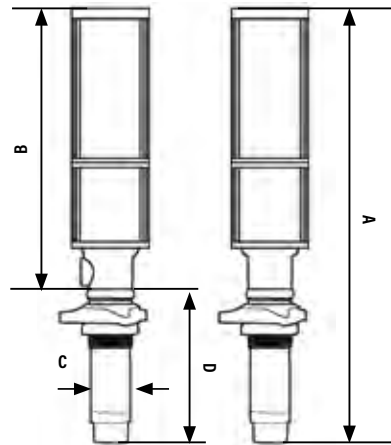

DIMENSIONS INCHES (MM)			
1130-015 & 1130-020			
A	B	C	D
23.5" (523.9 mm)	14 3/8" (285 mm)	2 4/5" (71 mm)	6 1/2" (158.7 mm)
1130-017			
21 8/9" (555.6 mm)	14 3/8" (285 mm)	2 1/8" (54 mm)	7 1/2" (190.5 mm)

TECHNICAL DATA	
Operating air pressure	10-150 psi (.7-10 bar)
Cycles per gallon	34 cyc/gal (8.98 cyc/liter)
Air consumption 100 psi (7 bar) & 4 gal/min (15 l/min)	19.70 SCFM
Max. fluid stall pressure @150 psi (10 bar) <sup>(1)</sup>	490 psi (33.7 bar)
Effective air piston diameter	2.5" (63.5 mm)
Free Flow pump delivery with SAE 10W30 oil, 68° F (20° C), 100 psi (7 bar) air pressure	8 gal/min (30 l/min)
Air inlet	1/4" NPT(F)
Fluid inlet	1" NPT(F); 1 1/2" NPT(M)
Fluid outlet	3/4" NPT(F)
Wetted materials	Steel, Nickel Plated Steel, Stainless Steel, Aluminum, Ultrathane, Buna-N™, and Nylon
Service Bulletin	SB 1064

NOTE: Thermal expansion of the fluid in a distribution system can cause an increase in system pressure that can damage lubrication system components. Use pressure relief valve kit included with this pump.

(1) Ensure that all hose fittings and piping are rated for fluid outlet pressures. Balcrank recommends a minimum of 3 x safety factor.

**Warning!** Do not use any Pride series products with flammable fluids.

Verify fluid compatibility with MSDS sheets.

Contact Balcrank for specific system design performance and technical data.

MODELS AVAILABLE	DESCRIPTION
1130-015	3:1 Bare carbon steel stub pump
1130-017	3:1 Bare carbon steel stub pump, flange mount
1130-020	3:1 Bare carbon steel pump with bung adapter

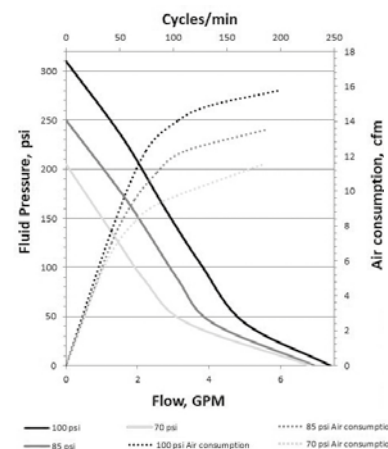

# Oil Piston Pumps PANTHER® HP 3:1 Pump Packages



16 GAL PUMP PACKAGES	16 GAL NON-METERED 1131-060	16 GAL METERED 1131-059
PUMP	1130-015	1130-015
MP FLUID HOSE 10' x 1/2"	8249-010	8249-010
SUCTION TUBE 1" NPT(M) X 18" - 30°	4412-044	4412-044
HANDLE W/FLEX-MEMORY EXT & 1/4 TURN	3320-024	3330-159
F/R MINI AUTO DRAIN 1/4" NPT(F)	3260-033	3260-033
AIR COUPLER 1/4"	3270-003	3270-003
AIR NIPPLE 1/4"	3270-004	3270-004
BUNG ADAPTER	4411-009N	4411-009N
LP HOSE 5' X 3/8"	8132-005	8132-005













55 GAL PUMP PACKAGES	55 GAL NON-METERED 1131-062	55 GAL METERED 1131-061
PUMP	1130-015	1130-015
MP FLUID HOSE 10' x 1/2"	8249-010	8249-010
SUCTION TUBE 1" NPT(M) X 26" - 30°	4412-046	4412-046
HANDLE W/FLEX-MEMORY EXT & 1/4 TURN	3320-024	3330-159
F/R MINI AUTO DRAIN 1/4" NPT(F)	3260-033	3260-033
AIR COUPLER 1/4"	3270-003	3270-003
AIR NIPPLE 1/4"	3270-004	3270-004
BUNG ADAPTER	4411-009N	4411-009N
LP HOSE 5' X 3/8"	8132-005	8132-005

1

# Oil Piston Pumps

## PANTHER® HP 3:1 & LYNX® 5:1 HD Pump Components

1

Suction tubes		<b>4412-044</b> 1" NPT(M) x 18" - 30° 16 gal drum	Control handles		<b>3330-159</b> DR, Flex-mem. ext., 1/4 turn for oil
		<b>4412-046</b> 1" NPT(M) x 26" - 30° 55 gal drum			<b>3330-205</b> MO, Flex-mem. ext., 1/4 turn for oil
		<b>4412-045</b> 1" NPT(M) x 21" - 30° 165/280 gal bench tank			<b>3330-192</b> MR, Qts., Flex-mem. ext., 1/4 turn for oil
		<b>4412-048</b> 1" NPT(M) x 30" - 30° 165/280 gal bench tank double tap	Wall mount kit		<b>4410-022</b> Wall mount kit for PANTHER® 8132-005 LP Hose 5' x 3/8" 8249-005 MP Hose 5' x 1/2" 8181-006 Suction Hose 6' x 1" 4412-052 Suction Tube 1" NPT(M) x 60" - 30° 4411-009N Bung Adapter 4411-008 Wall mount bracket
		<b>4412-047</b> 1" NPT(M) x 28" - 30° 250 gal bench tank double tap			
		<b>4412-051</b> 1" NPT(M) x 42" - 30° 275/330 gal horizontal obround double tap			
		<b>4412-052</b> 1" NPT(M) x 60" - 30° 330 gal vertical obround			
		<b>4412-049</b> 1" NPT(M) x 32" - 30° 275 gal tote			
		<b>4412-050</b> 1" NPT(M) x 39" - 30° 330 gal tote	Wall mount bracket		<b>4411-008</b> Wall mount bracket for LYNX® and Panther® HP
Bung adapter		<b>4411-018N</b> Double tap bushing, nickel plated stainless steel; for use with Panther® HP W/ pressure relief	Dollies		<b>4310-001</b> Band dolly, 16 gal/120 lb
Filter regulator (F/R)		<b>3260-033</b> F/R mini auto drain 1/4" NPT(F)  See pg. 165 for complete listing			<b>4310-003</b> Band dolly, 16 gal/120 lb wide track
Dispense hose		<b>8249-005</b> Dispense hose 5' x 1/2"	Carts		<b>4310-004</b> Dolly, 55 gal/400 lb HD
		<b>8263-010</b> Dispense hose 10' x 3/4"			<b>4320-010</b> 4 Wheel drum cart: 120 lb/16 gal
		<b>8263-016</b> Dispense hose 16' x 3/4"			<b>4320-013</b> 3 Wheel drum cart: 400 lb/55 gal
Connecting hose kit		<b>4410-054</b> Connecting hose kit PANTHER®: 8132-005 LP Hose 5' x 3/8" 8249-005 MP Hose 5' x 1/2" 3270-003 Coupler 1/4" 3270-004 Nipple 1/4" 3270-053 Bushing 3/4" x 1/2"	Hose reel mount kit		<b>4320-014</b> Heavy duty drum cart: 400 lb/55 gal, 3 wheels with rear locking caster (to mount hose reel, use 2230-036 hose reel mount kit)
					<b>2230-036</b> Hose reel mount kit for 4320-014 Heavy duty drum cart

Note: Pump packages include all hoses and adapters required for connecting an oil pump to the air supply and oil dispense line. Balcrank does not provide wall mounting hardware (nuts, bolts, and anchors) for lube packages.

# Control Handles MO Meter (Mechanical Oval Gear Meter)



See Dispense nozzle OD for important details

TECHNICAL DATA	
Units of measure	Quarts & Liters (totalizer Gallons)
Accuracy	+/- 1%
Flow Rate	0.25 - 8 gal/min (1 - 30 l/min)
Maximum pressure	1,000 psi (70 bar)
Swivel inlet	1/2" NPT(F)
Dispense Nozzle OD	Auto = 0.605" Manual 1/4 turn for OIL = 0.705" Manual 1/4 turn for ATF= 0.315" Verify ID of ATF fill port for compatibility
Operating temperature	14 °F to 140 °F (-10 °C to 60 °C)
Weight	4 lb (1.80 kg)
Compatible Fluids	Oil, transmission fluid, hydraulic fluid, and anti-freeze
Wetted Materials	Acetal, aluminum, stainless steel, NBR, Zinc plated steel, TPU, Polyamide
Service Bulletin	SB 313

Dimensions inches (mm)

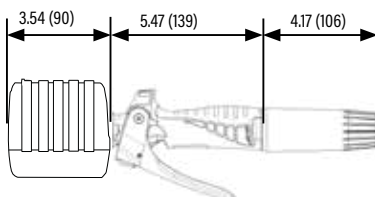

833398 Multi Colored set; red, yellow, green, blue (4 pcs)



## Features

- 6-digit totalizer; keeps lifetime record of volume dispensed in gallons
- Meter with odometer display, works without batteries and performs well in all environments
- No calibration required; precision machined metering chamber assures repeatable accuracy
- Ergonomically designed grip handle for optimum comfort
- Unique 1/4 turn manual non-drip tip; fast, simple
- Included swivel hose-end cover, protects vehicle or machine surfaces from scratches

### Fluids

- Synthetic and mineral based lubricants
- Gear Oil
- Hydraulic oil and fluids
- ATF
- Anti-freeze (Glycol) and anti-freeze water solution

### Markets Served

- Car and truck dealers
- Fast lube and maintenance shops
- Fleets
- Mining and construction
- Lube trucks

MODELS AVAILABLE	EXTENSION TYPE & NOZZLE	EXTENSION CODE U/M	
Verify ID of ATF fill port for compatibility.			
3330-205	Flex-memory 1/4 turn - OIL	3332-093	QT
3330-206	Flex 90 1/4 turn - ATF	3332-104	QT
3330-207	Rigid 1/4 turn - OIL	3332-091	QT
3330-208	Flex 90 1/4 turn - OIL	3332-092	QT
3330-212	Flex-memory 1/4 turn - OIL	3332-093	L
3330-213	Flex 90 1/4 turn - ATF	3332-104	L
3330-214	Rigid 1/4 turn - OIL	3332-091	L
3330-215	Flex 90 1/4 turn - OIL	3332-092	L
3330-204	Bare	-	QT
3330-211	Bare	-	L

# Control Handles EP Meter (Electronic Preset Meter)



3

### TECHNICAL DATA

Units of measure	Quarts, pints, gallons, liters
Accuracy	+/- 0.5 %
Flow Range	0.25-10 gal/m (1-38 l/m)
Maximum pressure	1,000 psi (70 bar)
Swivel Inlet	1/2" NPT(F)
Battery	4 x alkaline "AA"
Weight	5.5 lb (2.5 kg)
Compatible Fluids	Oil, transmission fluid, hydraulic fluid, and anti-freeze
Wetted Materials	Acetal, stainless steel, Buna-N™, brass, polyurethane
Service Bulletin	SB 3109

Dimensions inches (mm)

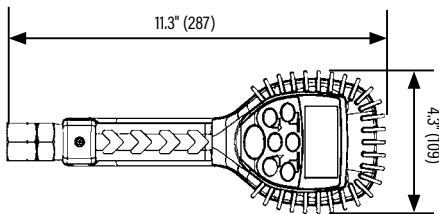

## Features

Preset dispensing allows hands-free operation as the meter automatically shuts off once the desired preset amount is reached.

- Programmable for quarts, pints, gallons, liters
- Quick recall of last preset quantity
- Operates in manual or automatic preset mode
- 2 totalizers: re-settable total & accumulated total
- Emergency override; closes the valve immediately stopping flow
- Low battery indicator
- Can be calibrated for different fluid viscosities

### Fluids

- Synthetic and mineral based lubricants
- Gear oil
- Hydraulic fluids
- ATF

### Markets Served

- Auto and truck dealerships
- Truck fast lube and maintenance shops
- Fleets
- Mining and construction
- Railroad and mass transit

MODELS AVAILABLE	DESCRIPTION
<b>3331-029</b>	Rigid Hi-Flow
<b>3331-030</b>	Flex Hi-Flow
<b>3331-028</b>	Bare

# Piston Pump Tankless Packages

For use with steel single and double wall tanks

**All packages include:**

- DR Handle w/flex-m ext. & 1/4 turn manual tip for oil
- F/R auto drain 1/4" NPT(F)
- 2.5' reel inlet hose
- Evolution series hose reel, 1/2" x 30' or 50' or Classic series hose reel 1/2" x 30' or 50' (only for medium and heavy duty)
- Pump connecting hose kit
- Piston pump - choice of LYNX® 3:1, LYNX® HD 5:1, or Panther® 3:1

## Light Duty Applications

- Tank packages
- Low volume, small service centers



## Medium Duty Applications

- Tank packages
- Low to medium volume, small service centers



## Medium/Heavy Duty Applications

- Tank packages
- Medium volume service centers



## Features

Suitable for dispensing of all petroleum based and synthetic oils and similar products up to SAE 90. Packages may be mounted to a variety of tanks including Balcrank's UL 142 single and double wall tanks. Available in workbench, vertical obround, and horizontal obround styles.

MODELS AVAILABLE	DESCRIPTION		
1132-016	Tankless Package, LYNX®/30', DR-Flex-M	4410-054	Pump Hose Kit
	1110-007 LYNX® 3:1 Bare Pump	3330-159	DR Handle w/flex-m ext.
	2140-013 Evo Reel 30' x 1/2" for Oil	3260-065	F/R manual 1/4" NPT(F)
1132-017	Tankless Package, LYNX®/50', DR-Flex-M	4410-054	Pump Hose Kit
	1110-007 LYNX® 3:1 Bare Pump	3330-159	DR Handle w/flex-m ext.
	2140-014 Evo Reel 50' x 1/2" for Oil	3260-065	F/R manual 1/4" NPT(F)

MODELS AVAILABLE	DESCRIPTION		
1132-020	Tankless Package, LYNX® HD/30', DR-Flex-M	4410-054	Pump Hose Kit
	1110-012 LYNX® HD 5:1 Bare Pump	3330-159	DR Handle w/flex-m ext.
	2140-013 Evo Reel 30' x 1/2" for Oil	3260-065	F/R manual 1/4" NPT(F)
1132-021	Tankless Package, LYNX®/50', DR-Flex-M	4410-054	Pump Hose Kit
	1110-012 LYNX® HD 5:1 Bare Pump	3330-159	DR Handle w/flex-m ext.
	2140-014 Evo Reel 50' x 1/2" for Oil	3260-065	F/R manual 1/4" NPT(F)

MODELS AVAILABLE	DESCRIPTION		
1132-018	Tankless Package, Panther®/30', DR-Flex-M	4410-055	Pump Hose Kit
	1130-020 Panther® 3:1 Bare Pump	3330-159	DR Handle w/flex-m ext.
	2140-013 Evo Reel 30' x 1/2" for Oil	3260-065	F/R manual 1/4" NPT(F)
1132-019	Tankless Package, Panther®/50', DR-Flex-M	4410-055	Pump Kit
	1130-020 Panther® 3:1 Bare Pump	3330-159	DR Handle w/flex-m ext.
	2140-014 Evo Reel 50' x 1/2" for Oil	3260-065	F/R manual 1/4" NPT(F)



## AODD Used Fluid Equipment for Oil

### CF30 Series Evacuation Package

Evacuation system for used oil or anti-freeze disposal



1121-022 CF30 EVACUATION PACKAGE FOR USED OIL	
INCLUDES	
1120-040	Aluminum CF30 Diaphragm Pump
8134-005	LP Hose Assembly Suction Rated 5' x 3/8"
8264-005	MP Hose Assembly 5' x 3/4"
8181-006	LP Hose Assembly 6' x 1"
4140-017	Cam-lock Coupler 1"
4140-053	Cam-lock Dust Plug 1"
3230-019	LP Air Ball Valve 3/8" NPT(F) no bleed
3230-022	LP Air Ball Valve 1" NPT(F) no bleed
3260-035	F/R Auto Drain 3/8" NPT(F)
4411-025	Mounting Bracket for AODD Pumps
3120-219	Y-Strainer 1" NPT(F)

**Warning!** Not to be used with flammable fluids.

### CF50 Series Evacuation Package

Evacuation system for used oil or anti-freeze disposal



1121-024 CF50 EVACUATION PACKAGE FOR USED OIL	
INCLUDES	
1120-037	Aluminum CF50 Diaphragm Pump
8134-005	LP Hose Assembly 5' x 3/8"
8281-005	MP Hose Assembly 5' x 1"
8182-005	LP Hose Assembly Suction Rated 5' x 1"
4140-017	Cam-lock Coupler 1"
4140-053	Cam-lock Dust Plug 1"
3230-019	LP Air Ball Valve 3/8" NPT(F) no bleed
3230-022	LP Air Ball Valve 1" NPT(F) no bleed
3260-035	F/R Auto Drain 3/8" NPT(F)
4411-036	Mounting Bracket for CF50 AODD Pumps
3120-219	Y-Strainer 1" NPT(F)

**Warning!** Not to be used with flammable fluids.

### Conventional 1" UL Evacuation Package

Evacuation system for use when UL is specified. Package designed for used oil evacuation.



1121-026 UL SPECIFIED EVACUATION PACKAGE FOR USED OIL			
INCLUDES			
1120-015S	1" UL Aluminum AODD Pump	3230-019	LP Air Ball Valve 3/8" NPT(F) no bleed
8134-005	LP Hose Assembly 5' x 3/8"	4140-017	Cam-lock Coupler 1"
3260-035	F/R Auto Drain 3/8" NPT(F)	4140-053	Cam-lock Dust Plug 1"
8281-005	MP Hose Assembly 5' x 1"	4411-016	Mounting Bracket for Diaphragm Pump
8182-005	LP Hose Assembly Suction Rated 5' x 1"	3120-219	Y-Strainer 1" NPT(F)
3230-022	LP Air Ball Valve 1" NPT(F) no bleed		

**Warning!** Not to be used with flammable fluids.

7